

The Spectrum Monitoring System of Smog-1 Satellite

Levente Dudás, László Szűcs, dr. András Gschwindt
Dept. of Broadband Infocommunications and Electromagnetic Theory
Budapest University of Technology and Economics
Budapest, Hungary
dudas@mht.bme.hu, szucs@mht.bme.hu, gschwindt@mht.bme.hu

Abstract—Our aim is to design and develop a PocketQube-class satellite as one possible continuation of Masat-1, the first Hungarian satellite. The planned payload of Smog-1 is an UHF band spectrum monitoring system. This system is able to measure the UHF band digital terrestrial TV signal levels around the world on a low Earth orbit as RF smog. The spectrum measurement system were flown by high altitude meteorological balloon.

Keywords— *PocketQube, spectrum monitoring system, high altitude ballon mesurements*

I. INTRODUCTION

The Smog-1, as a PocketQube-class satellite, is 5 x 5 x 5 cm cube with 175 g total mass. Nowadays, this kind of PocketQube is not working on low Earth orbit. The main subsystems of Smog-1 are: EPS, OBC, COM and SP.

The EPS is the electrical power system. The surface of the cube is covered by solar panels, as the source of energy. The main tasks of the EPS are to control the working point of the solar panels independently to reach the maximal input DC power, to charge the Li-ion accumulator to be able to work in the dark side of the Earth, and to produce stable 3.3 V power supply voltage to the other subsystems.

The OBC is the on-board computer. The OBC controls the operation of the on-board electronics as COM (communication system) and SP (spectrum monitoring system). The OBC is responsible for the on-board data collection and handling (these data will be the radiated telemetry data by COM).

The task of the COM (communication system) is to realize two-way data connection between the satellite and the ground stations. This radio transmission is on the 70 cm UHF radio amateur band, mainly because of the size of the onboard antenna, which has to be opened from the cube.

The payload of the Smog-1 is the SP (spectrum monitoring system). This measurement system is to monitor the UHF band signal levels of the digital terrestrial TV transmitters, radiated from the Earth on a low Earth orbit. On UHF band, some parts of these TV signals are radiated to the space as radiofrequency smog (the name of the satellite Smog-1 is from this RF smog), so this power is lost power. [3-5]

The first version of the Smog-1 skeleton is in Fig. 1.

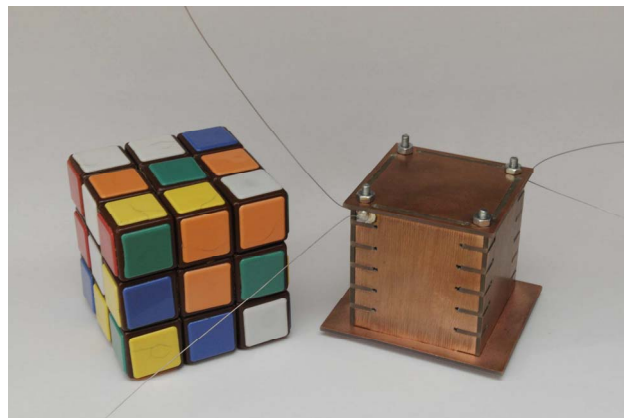

Fig. 1. The Rubic's Cube is on the left, the skeleton of the Smog-1 is on the right.

II. POWER LEVELS

Because of the size and mass of the satellite, there is about 300 mW input DC power from the Sun. In space, around the Earth there is 1360 W/m² input power density. The size of the solar panel on one side of the cube is 40 x 40 mm, so the theoretically input power is 2.17 W. The efficiency of the solar panel is equal to 28 %, so the input power reaches 600 mW. If the satellite is on low Earth orbit, about 60 % of the time period is on sunlight, and 40 % in dark. This causes 360 mW DC power. The efficiency of the realized maximal power point tracker circuit (step-up converter with MPPT) is 83 %, so the input power will be 300 mW DC which can be stored into the accumulator. [3-5]

So, the highest power consumption cannot be higher than 300 mW. This means that the output RF power of the communication system on-board the satellite cannot exceed 100 mW RF, with 33 % efficiency of the power amplifier on the 437 MHz UHF band in case of 100 % transmit duty-cycle.

III. THE COMMUNICATION

Table 1 contains the simplified and estimated link budget of the communication between the satellite and the ground station in case of 400 km circular orbit.

TABLE I. ESTIMATED LINK BUDGET

Frequency	437 MHz
Wavelength	0,69 m
Orbit	400 km
Maximal Distance	2293 km
Free Space Loss	152 dB
Satellite Transmit Power	20 dBm
Satellite Antenna Gain	0 dBi
Ground Station Antenna Gain	16 dBi
Received Signal Level at GND	-116 dBm
Radio Channel Data Rate	5000 bit/s
2-GMSK Bandwidth	7500 Hz
Input Thermal Noise Level	-133 dBm
Input Signal to Noise Ratio	16 dB

The power of the onboard transmitter is 100 mW (20 dBm) and the onboard antenna is more or less omnidirectional antenna with 0 dBi gain. The antenna pattern of the on-board antenna is in Fig. 2. [1,2]

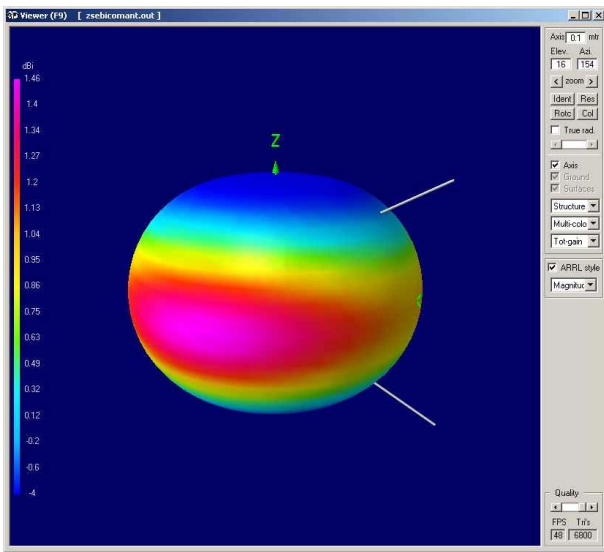

Fig. 2. The radiation pattern of the on-board antenna

The quasi omnidirectional antenna is necessary, because of the almost random movement of the satellite during passes. This causes at least 6 dB fluctuation at the downlink path.

The radio wave propagation between the satellite and GND (ground station) is line-of-sight with some dB atmospheric loss. The modulation of the transmission is 2-FSK (in practice this will be 2-GMSK), because of the used single-chip transceiver (Silabs).

The computed SNR (with the fluctuation) is in 10-16 dB range, which means 10^{-3} - 10^{-8} un-coded BER value. The used data rate suits to the bandwidth of a conventional radio amateur transceiver (less than 12.5 kHz).

IV. THE PAYLOAD

The payload of the satellite will be a small sized spectrum analyzer on the UHF TV band from 460 to 860 MHz frequency range. The receiver part of the previously mentioned transceiver is able to work in RF scanner mode. This transceiver chip measures the received signal strength level on

a given frequency and bandwidth with high dynamic range and with 1 dB accuracy. The measured RSSI curve of the spectrum monitoring receiver is in Fig. 3.

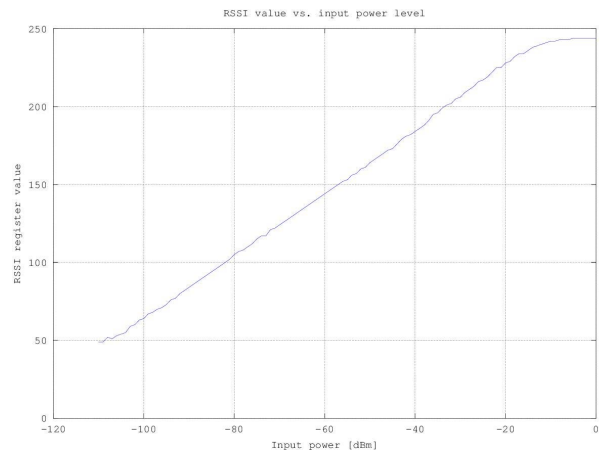

Fig. 3. Spectrum monitor receiver: RSSI versus input power

The antenna of the spectrum monitoring system will be a 2 x 18 cm long single dipole, with symmetrical load – Fig. 4.

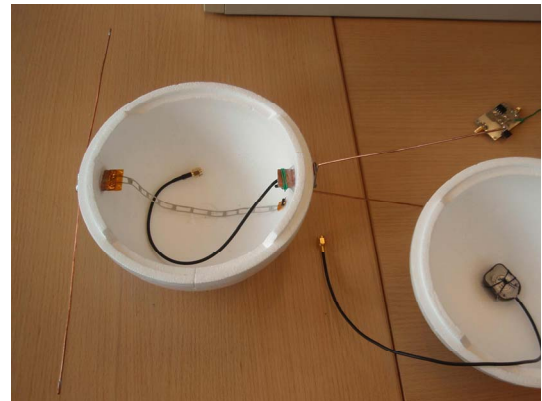

Fig. 4. The measurement antenna – dipole is on the left, the radio communication antenna is in the middle, and the GPS antenna in on the right (only on the high altitude balloon).

The simulated input impedance of the measurement antenna is in Fig. 5. [2]

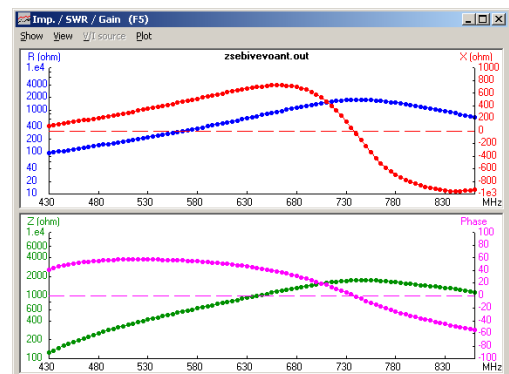

Fig. 5. Spectrum monitor antenna impedance

The real part of the impedance in the given frequency range is between 100 and 2000 Ohm. This is connected to the symmetrical receiver input 450 Ohm parallel with 2 pF.

So, it is necessary to calibrate the measuring system in an anechoic chamber at BUTE. The calibration vector is in Fig. 6.

The RSSI value from the spectrum monitoring receiver is corrected by this calibration vector to be able to produce real input signal level in a given frequency.

The bandwidth of the monitoring receiver is in 1.5 – 850 kHz range, controlled by the configuration software.

The bandwidth of the digital terrestrial TV channel is 8 MHz, so the used bandwidth is 800 kHz. In this case, the only thing is to correct the measured data by increasing the RSSI level with 10 dB, because the bandwidth of the receiver is 10 times less than the bandwidth of the transmitted TV signal.

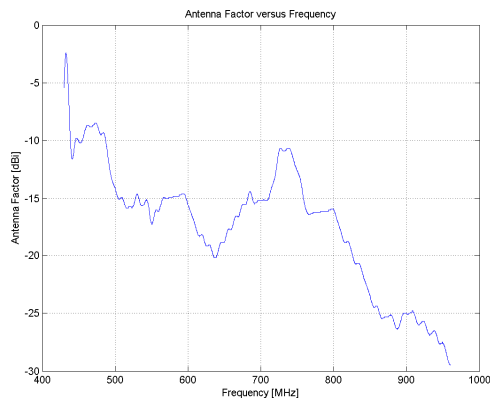

Fig. 6. The spectrum monitor antenna factor (measured) versus frequency

V. THE EXPERIMENTAL MODEL OF THE SPECTRUM MONITOR

In 2014, there were 4 flights with (HAB) high altitude meteorological balloon to measure the TV signal levels over the ground in Hungary. The block scheme of the measurement system onboard the HAB is in Fig. 7.

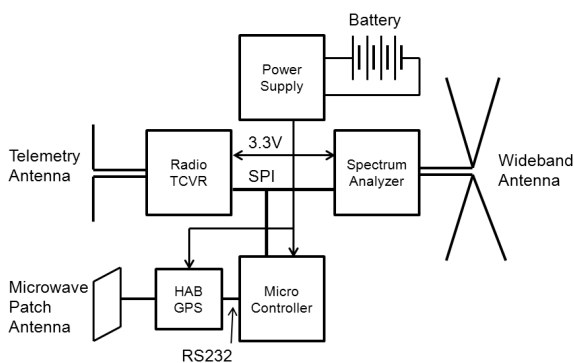

Fig. 7. The block scheme of the spectrum monitoring system onboard HAB

The realized and calibrated hardware of the experimental monitoring system is in Fig. 8.

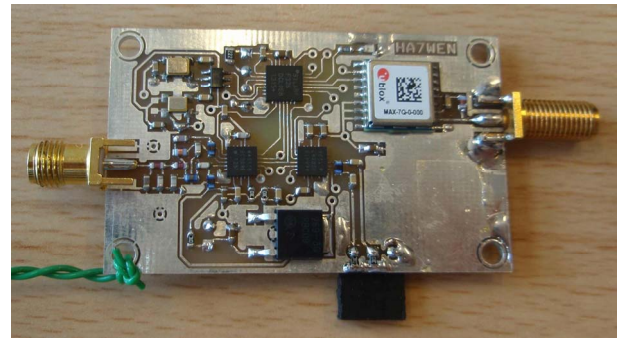

Fig. 8. The experimental model of the spectrum monitoring system

There are several electronic components: SMA connector and the radio transceiver chip is on the left, the spectrum monitoring system is in the middle (the symmetrical antenna connection in on the bottom), left up is the GPS receiver (because of the position of the HAB – in case of satellite, there is Kepler data, so the position of the satellite will be known), on the top middle is the control computer, and on the top left are the reference oscillators like TCXOs (temperature compensated crystal oscillators). [3,4]

VI. HIGH ALTITUDE BALLOON FLIGHT

The experimental spectrum monitoring system is flown by high altitude balloon from the meteorological station in Budapest – Fig. 10.



Fig. 9. Before flight in Budapest

The route of the fourth flight is in Fig. 10. The highest point of the flight is 34 km.

The task of the experimental monitoring system was to measure the TV spectrum during the flight while recording the actual GPS position of the payload and radiate the measurement results down to the automated and remote controlled ground station of Masat-1 (in this case, the ground station is not tracking a satellite according to the actual Kepler data, but tracking the balloon according to its GPS data) [5].

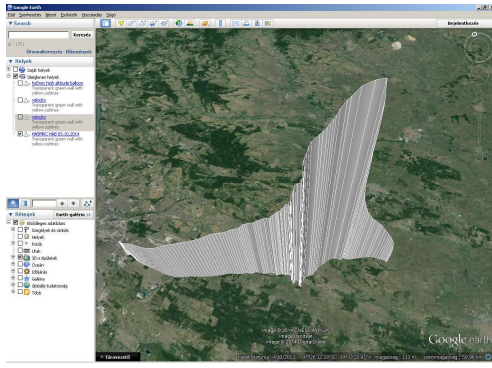

Fig. 10. The route of the balloon at the fourth flight. On the left is Budapest, as the start point.

VII. SPECTRUM MEASUREMENT RESULTS

The compensated received signal strength level versus frequency and height of the balloon is in Fig. 11.

In lower heights, only the signals of the local TV transmitters are highly visible on 500, 610, 640, 750 and 770 MHz. If the height of the balloon is increasing, other TV transmitter signals from neighbour countries start to be visible and then the total digital TV band is filling up.

The antenna of the 770 MHz TV transmitter has one high sidelobe, because of the -40 dBm RSSI at 7 km height (red point). This means that the radiated power to this direction is unuseful, it is lost, so it means RF smog.

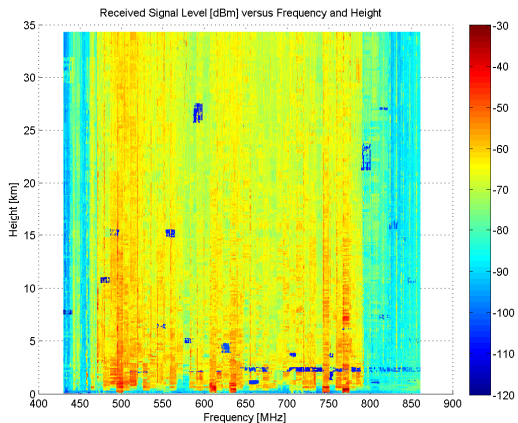

Fig. 11. Measured RSSI versus frequency and height

Further effect is in Fig. 11, so that the TV transmitters produce relatively high signal some km-s above the ground – it is also lost power. In case of satellite, e.g. on 400 km circular orbit, the only effect caused by the distance difference is approximately 20 dB additional attenuation, so the received signal level will be decreased (as offset).

The secondary task of the balloon flight was to measure the real radiation pattern of the COM antenna on the communication frequency band. So, the tracking station

periodically sent control signals to the balloon, and the balloon measured the RSSI at the input of the communication receiver and sent this value back to the ground station. Fig. 12 shows the maximum value of the theoretically received signal strength according to the transmit power, the antenna gain and the distance, and the measured RSSI value. The measured values are in a 10 dB range below the theoretically maximum, so the fluctuation of the COM antenna gain is 10 dB in practice.

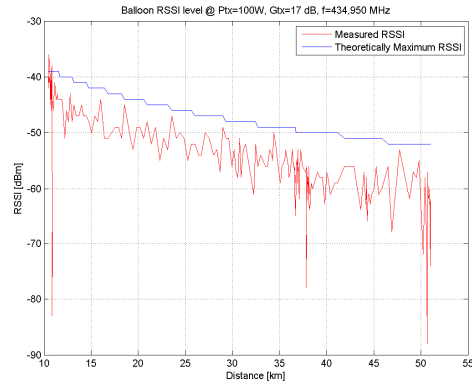

Fig. 12. Command RSSI onboard the balloon from the control station

VIII. CONCLUSION

According to the presented measurement results, the spectrum monitoring system is sensitive enough, has enough dynamic range to be mounted on-board the planned PocketQube-class satellite as a payload to measure the RF smog on the UHF band around the world on a low Earth orbit. The radio link between the satellite and the ground station can be closed such kind of relatively low transmit power and quasi omnidirectional COM antenna pattern with about 5 kbit/s (minimal required) data rate.

ACKNOWLEDGMENT

This development is supported by the National Media and Infocommunications Authority; special thanks to the staff of the Meteorological Station at Gilice-square of Hungarian Meteorological Society.

REFERENCES

- [1] RODDY, D., "Satellite Communications" Fourth Edition, McGraw Hill Higher Education, 2006
- [2] BALANIS, C. A., "Antenna Theory: Analysis and Design", Wiley-Interscience, 2005
- [3] Levente DUDÁS, Lajos VARGA, Rudolf SELLER, "The Communication Subsystem of Masat-1, the First Hungarian Satellite", Signal Processing, Symposium. Jachranka, Poland, 2009, pp. 1-4.
- [4] Levente DUDÁS, Lajos VARGA, "Masat-1 COM", Antenna Systems & Sensors for Information Society Technologies COST Action IC0603, Dubrovnik, 2010
- [5] Levente DUDÁS, Levente PÁPAY, Rudolf SELLER, "Automated and Remote Controlled Ground Station of Masat-1, the First Hungarian Satellite", International Conference Radioelektronika 2014, Pozsony, Slovakia, 2014